

# NAIS

## COMPACT FLAT POWER RELAY FOR HEATER LOADS

# JV-N RELAYS

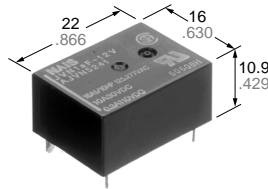

### FEATURES

- **High 16 A capacity**  
The contacts are high capacity 16A, 125 V AC.
- **Compact, flat type with low 10.9 mm .429 inch height**  
Compact flat type with low surface area of 16 × 22 mm .630 × .866 inch and height of 10.9 mm .429 inch.
- **High sensitivity at 200 mW**  
High sensitivity at 200 mW coil power consumption.

- **Represses contact terminal heat**  
The contact terminals are larger and thicker compared to the existing JV relay. This limits the rise in temperature of the terminals when there is a large current flowing to approx. 28°C 62°F (normal current of 16 A).
- **Conforms to the various safety standards**  
UL/CSA, TÜV approved.

### SPECIFICATIONS

#### Contact

Arrangement	1 Form A	
Initial contact resistance, max. (By voltage drop 6 V DC 1 A)	Max. 30 mΩ	
Contact material	Silver alloy	
Rating (resistive load)	Nominal switching capacity	16 A 125 V AC, 10 A 277 V AC 10 A 30 V DC, 10 A 125 V AC
	Max. switching power	2,770 VA, 300 W
	Max. switching voltage	277 V AC, 30 V DC
	Max. switching current	16 A (AC 125 V), 10 A (DC)
Expected life (min. ope.) Mechanical (at 180 cpm)	2×10 <sup>7</sup>	
Electrical at resistive load (at 20 cpm)	Sealed type 16 A 125 V AC, 10 A 30 V DC	10 <sup>5</sup>
	Flux-resistant type 10 A 125 V AC	3×10 <sup>5</sup>

#### Coil

Nominal operating power	200 mW (DC 4.5 to 48 V) 600 mW (DC 100 V)
-------------------------	--

#### Remarks

- \* Specifications will vary with foreign standards certification ratings.
- \*<sup>1</sup> Excluding contact bounce time
- \*<sup>2</sup> Excluding contact bounce time, without diode
- \*<sup>3</sup> By resistive method; nominal voltage applied to the coil; contact carrying current: 16A, at 70°C 158°F
- \*<sup>4</sup> Nominal voltage applied to the coil, at 60°C 140°F
- \*<sup>5</sup> Half-wave pulse of sine wave: 11 ms; detection time: 10 μs
- \*<sup>6</sup> Half-wave pulse of sine wave: 6 ms
- \*<sup>7</sup> Detection time: 10 μs
- \*<sup>8</sup> Refer to 5. Conditions for operation, transport and storage mentioned in AMBIENT ENVIRONMENT (Page 61).

#### Characteristics

Max. operating speed	20 cpm	
Operate time* <sup>1</sup> (at nominal voltage)	Max. 12 ms (DC 4.5 V to 48 V) Max. 8 ms (DC 100 V)	
Release time* <sup>2</sup> (at nominal voltage)	Max. 5 ms	
Initial insulation resistance	Min. 1,000 MΩ (at 500 V DC)	
Initial breakdown voltage (Detection current: 10 mA)	Between open contacts	1,000 Vrms for 1 min.
	Between contacts and coil	2,500 Vrms for 1 min.
Surge voltage between contact and coil	Min. 4,500 V	
Temperature rise	Max. 45°C (DC 4.5 V to 48 V) * <sup>3</sup> Max. 55°C (DC 100 V) * <sup>4</sup>	
Conditions in case of operation, transport and storage* <sup>8</sup>	Ambient temperature -40 to 70°C -40 to 158°F (DC 4.5 to 48 V) -40 to 60°C -40 to 140°F (DC 100V) Humidity: 5 to 85 % R.H. (Note freezing and condensing at low temperature) Air pressure: 86 to 106 kPa	
Shock resistance	Functional	Min. 200 m/s <sup>2</sup> {20G}* <sup>5</sup>
	Destructive	Min. 1,000 m/s <sup>2</sup> {100G}* <sup>6</sup>
Vibration resistance	Functional	10 to 55 Hz * <sup>7</sup> at double amplitude of 1.6 mm
	Destructive	10 to 55 Hz at double amplitude of 2 mm
Unit weight	Approx. 8g .28 oz	

### TYPICAL APPLICATIONS

- AV equipment: TV's, VTR's, etc.
- OA equipment
- HA equipment

### ORDERING INFORMATIONS

Ex. JVN 1a F - 4.5 V

Contact arrangement	Protective construction	Coil voltage (DC)
1a: 1 Form A	Nil: Sealed type F: Flux-resistant type	4.5, 6, 9, 12, 18, 24, 48, 100 V

UL/CSA, TÜV approved type is standard.

# JV-N

## TYPES AND COIL DATA (at 20°C 68°F)

Part No.		Nominal voltage, V DC	Pick-up voltage V DC (max.)	Drop-out voltage V DC (min.)	Coil resistance, W (±10%)	Nominal operating current, mA (±10%)	Nominal operating power, mW	Max. allowable voltage, V DC
Sealed type	Flux-resistant type							
JVN1a-4.5V	JVN1aF-4.5V	4.5	3.375	0.23	101	44.4	200	6.75
JVN1a-6V	JVN1aF-6V	6	4.5	0.3	180	33.3	200	9
JVN1a-9V	JVN1aF-9V	9	6.75	0.45	405	22.2	200	13.5
JVN1a-12V	JVN1aF-12V	12	9	0.6	720	16.7	200	18
JVN1a-18V	JVN1aF-18V	18	13.5	0.9	1,620	11.1	200	27
JVN1a-24V	JVN1aF-24V	24	18	1.2	2,880	8.3	200	36
JVN1a-48V	JVN1aF-48V	48	36	2.4	11,520	4.2	200	72
JVN1a-100V	JVN1aF-100V	100	60	4	16,600	6	600	110

## DIMENSIONS

mm inch

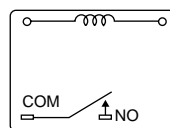
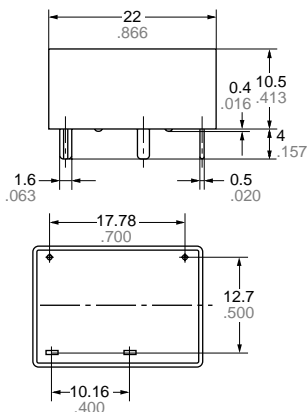

### PC board pattern

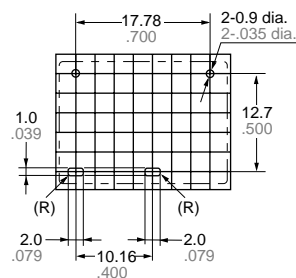

**Dimension:**  
 Max. 1mm .039 inch: ±0.2 ±.008  
 1 to 5mm .039 to .197 inch: ±0.3 ±.012  
 Min. 5mm .197 inch: ±0.4 ±.016

**General tolerance**  
 ±0.2 ±.008  
 ±0.3 ±.012  
 ±0.4 ±.016

## REFERENCE DATA

### 1. Max. switching power

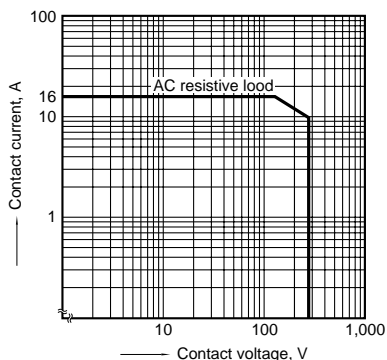

### 2. Operate/release time

Sample: JVN1aF-12 V, 6 pcs.

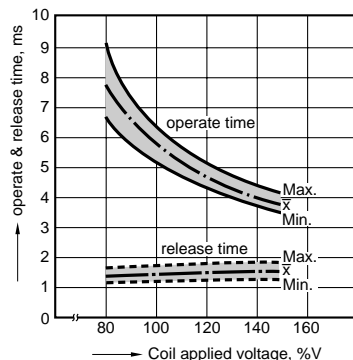

### 3. Coil temperature rise

Sample: JVN1aF-12 V, 6 pcs. point measured: coil inside  
 Contact current: 16 A

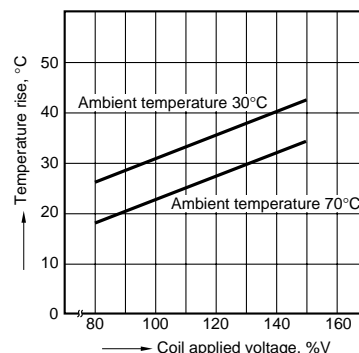

### 4. Ambient temperature characteristics

Sample: JVN1aF-12 V, 6 pcs.

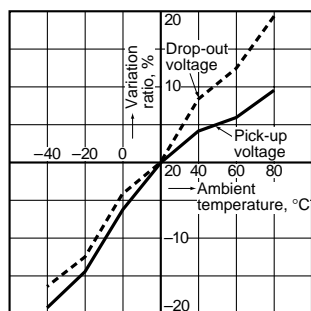

### 5. Life curve

Operation frequency: 20 times/min.  
 Ambient temperature: room temperature

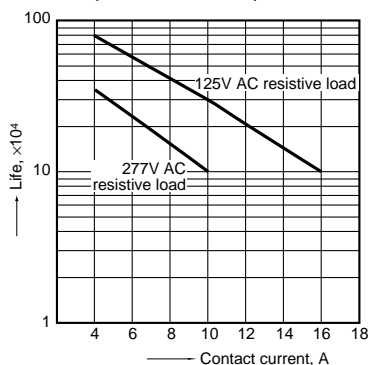

**For Cautions for Use, see Relay Technical Information (Page 48 to 76).**