

# DATA SHEET

## THICK FILM CHIP RESISTORS

Introduction



## INTRODUCTION

Data in data sheets is presented - whenever possible - according to a 'format', in which the following chapters are stated:

- TITLE
- SCOPE
- APPLICATION
- FEATURES
- ORDERING INFORMATION
- MARKING
- CONSTRUCTION
- DIMENSIONS
- ELECTRICAL CHARACTERISTICS
- PACKING STYLE AND PACKAGING QUANTITY
- FUNCTIONAL DESCRIPTION
- TESTS AND REQUIREMENTS

The chapters listed above are explained in this section "Introduction Thick Film Chip Resistors", with detailed information in the relevant data sheet. Chapters "Mounting", "Packing", and "Marking" are detailed in separate sections.

## DESCRIPTION

All thick film types of chip resistors have a rectangular ceramic body. The resistive element is a metal glaze film. The chips have been trimmed to the required ohmic resistance by cutting one or more grooves in the resistive layer. This process is completely computer controlled and yields a high reliability. The terminations are attached using either a silver dipping method or by applying nickel terminations, which are covered with a protective epoxy coat, finally the two external terminations (matte tin on Ni-barrier) are added.

The resistive layer is coated with a colored protective layer. This protective layer provides electrical, mechanical and/or environmental protection - also against soldering flux and cleaning solvents, in accordance with "MIL-STD-202G", method 215 and "IEC 60115-4.29". Yageo thick film chip resistor is flameproof and can meet "UL94V-0".

## ORDERING INFORMATION - I2NC & GLOBAL CLEAR TEXT CODE

Resistors are ordered in two ways. Both ways give logistic and packing information.

- CTC: This unique number is an easily-readable code. Global part number is preferred.
  - 15 digits code (PHYCOMP CTC): Phycomp branded products
  - 14~18 digits code (Global part number): Yageo/Phycomp branded products
- I2NC: In general, the tolerance, packing and resistance code are integral parts of this number.
  - Phycomp branded product

Further informations will be mentioned in the relevant data sheet.

## FUNCTIONAL DESCRIPTION

The functional description includes: nominal resistance range and tolerance, limiting voltage, temperature coefficient, absolute maximum dissipation, climatic category and stability.

The limiting voltage (DC or RMS) is the maximum voltage that may be continuously applied to the resistor element, see "IEC publications 60115-8".

The laws of heat conduction, convection and radiation determine the temperature rise in a resistor owing to power dissipation. The maximum body temperature usually occurs in the middle of the resistor and is called the hot-spot temperature.

In the normal operating temperature range of chip resistors the temperature rise at the hot-spot,  $T_m$ , is proportional to the power dissipated:  $\Delta T = A \times P$ .

The proportionality constant 'A' gives the temperature rise per Watt of dissipated power and can be interpreted as a thermal resistance in K/W. This thermal resistance is dependent on the heat conductivity of the materials used (including the PCB), the way of mounting and the dimensions of the resistor. The sum of the temperature rise and the ambient temperature is:

$$T_m = T_{amb} + \Delta T$$

where:

$$T_m = \text{hot-spot temperature}$$

$$T_{amb} = \text{ambient temperature}$$

$$\Delta T = \text{temperature rise at hot-spot.}$$

The stability of a chip resistor during endurance tests is mainly determined by the hot-spot temperature and the resistive materials used.

**SUMMARIZING**

| Description   | Relationship         |
|---|----------------------|
| Dimensions, conductance of materials and mounting determine | heat resistance      |
| Heat resistance × dissipation gives                         | temperature rise     |
| Temperature rise + ambient temperature give                 | hot-spot temperature |

**PERFORMANCE**

When specifying the performance of a resistor, the dissipation is given as a function of the hot-spot temperature, with the ambient temperature as a parameter.

From  $\Delta T = A \times P$  and  $T_m = T_{amb} + \Delta T$  it follows that:

$$P = \frac{T_m - T_{amb}}{A}$$

If P is plotted against  $T_m$  for a constant value of A, parallel straight lines are obtained for different values of the ambient temperature. The slope of these lines,

$$\frac{dP}{dT_m} = \frac{1}{A}$$

is the reciprocal of the heat resistance and is the characteristic for the resistor and its environment.

**THE TEMPERATURE COEFFICIENT**

The temperature coefficient of resistance is a ratio which indicates the rate of increase (decrease) of resistance per degree (°C) increase (decrease) of temperature within a specified range, and is expressed in parts per million per °C (ppm/°C).

**EXAMPLE**

If the temperature coefficient of a resistor of  $R_{nom} = 1 \text{ k}\Omega$  between  $-55 \text{ }^\circ\text{C}$  and  $+155 \text{ }^\circ\text{C}$  is  $\pm 200 \text{ ppm}/^\circ\text{C}$ , its resistance will be:

at  $25 \text{ }^\circ\text{C}$ :  
 $1,000 \text{ } \Omega$  (nominal = rated value)

at  $+155 \text{ }^\circ\text{C}$ :  
 $1,000 \text{ } \Omega \pm (130 \times 200 \text{ ppm}/^\circ\text{C}) \times 1,000 \text{ } \Omega$   
 $= 1,026 \text{ } \Omega$  or  $974 \text{ } \Omega$

at  $-55 \text{ }^\circ\text{C}$ :  
 $1,000 \text{ } \Omega \pm (80 \times 200 \text{ ppm}/^\circ\text{C}) \times 1,000 \text{ } \Omega$   
 $= 1,016 \text{ } \Omega$  or  $984 \text{ } \Omega$

If the temperature coefficient is specified as  $\leq 200 \text{ ppm}/^\circ\text{C}$  the resistance will be within the shaded area as shown in Fig. 1.

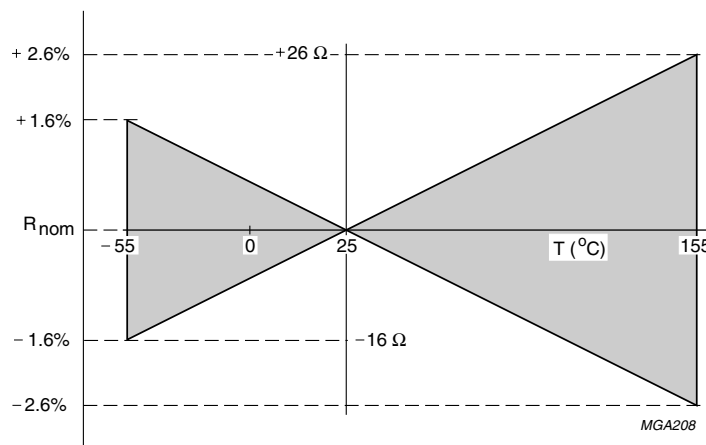


Fig. 1 Temperature coefficient.

**NOISE**

Most resistors generate noise due to the passage of current through the resistor. This noise is dependent on the amount of current, the resistive material and the physical construction of the resistor. The physical construction is partly influenced by the laser trimming process, which cuts a groove in the resistive material. Typical current noise levels are shown in Fig. 2.

**FREQUENCY BEHAVIOUR**

Resistors in general are designed to function according to ohmic laws. This is basically true of rectangular chip resistors for frequencies up to 100 kHz. At higher frequencies, the capacitance of the terminations and the inductance of the resistive path length begin to have an effect.

Basically, chip resistors can be represented by an ideal resistor switched in series with a coil and both switched parallel to a capacitor. The values of the capacitance and inductance are mainly determined by the dimensions of the terminations and the conductive path length. The trimming pattern has a negligible influence on the inductance, as the path length is not influenced. Also, its influence on the capacitance is negligible as the total capacitance is largely determined by the terminations.

The environment surrounding chips (e.g. landing paths, nearby tracks and the material of the printed-circuit board) has a large influence on the behaviour of the chip on the printed-circuit board.

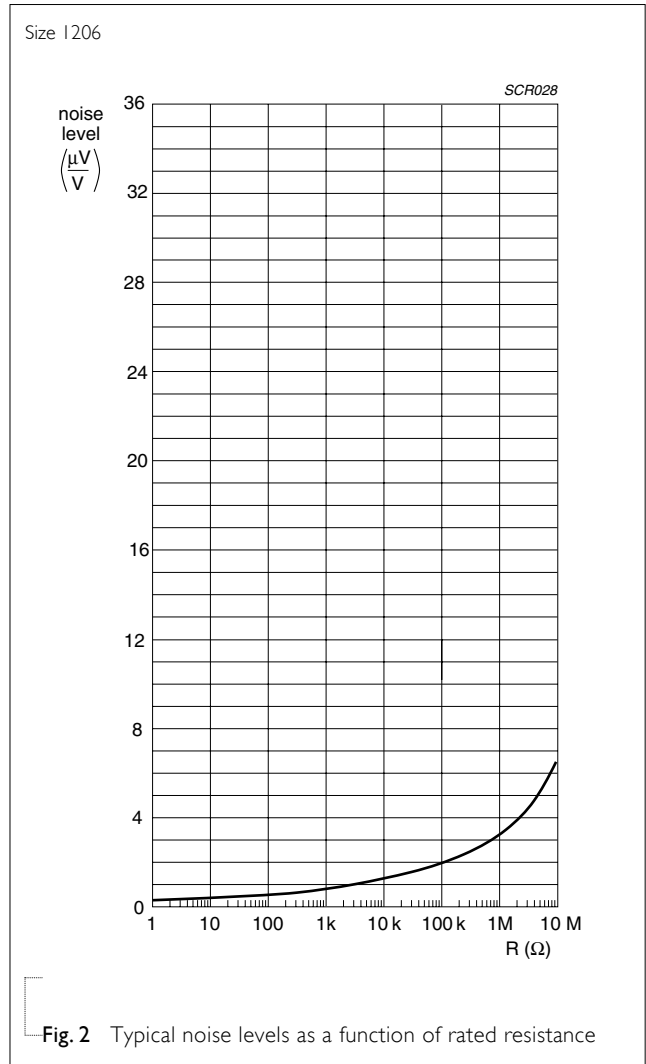
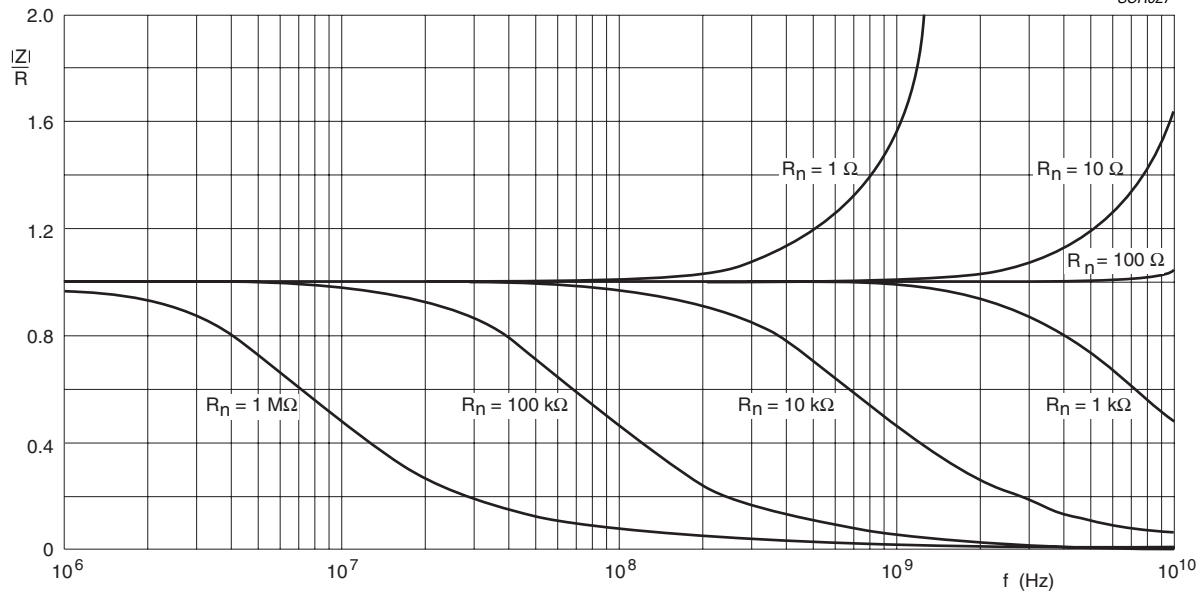


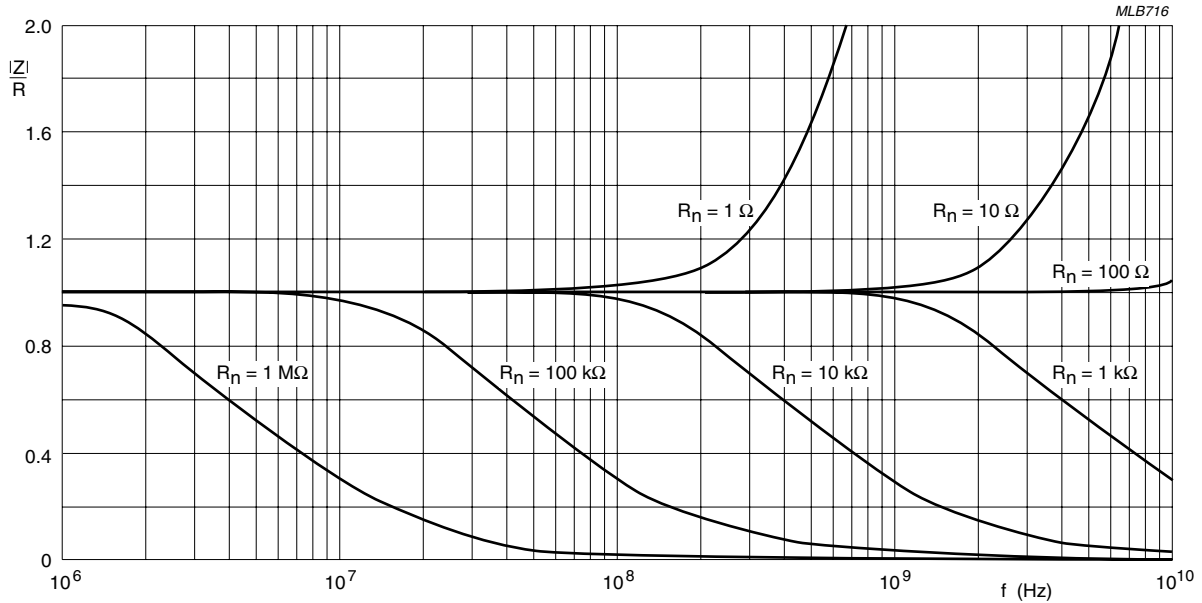
Fig. 2 Typical noise levels as a function of rated resistance

Size 0402



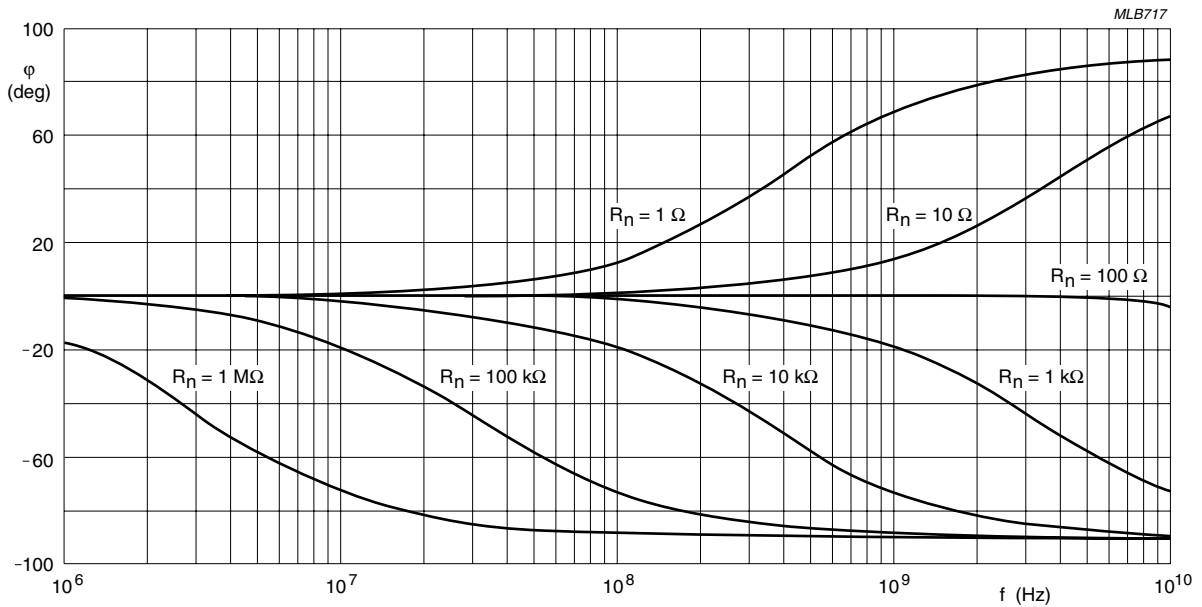
**Fig. 4** Impedance as a function of frequency for a chip resistor

Size 0603



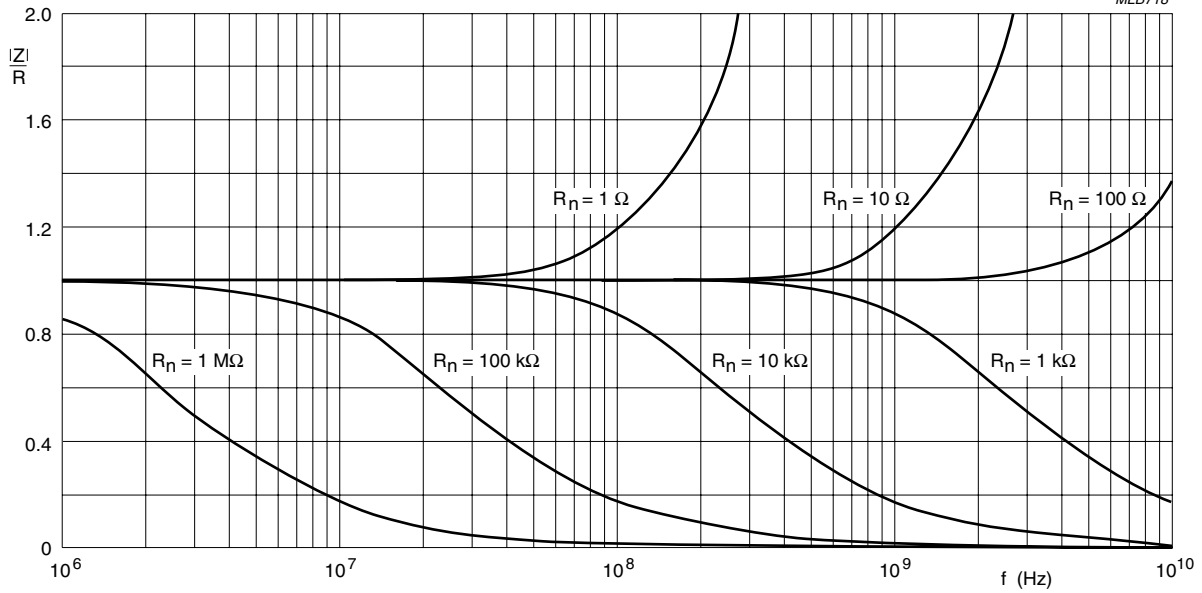
**Fig. 5** Impedance as a function of frequency for a chip resistor

Size 0603



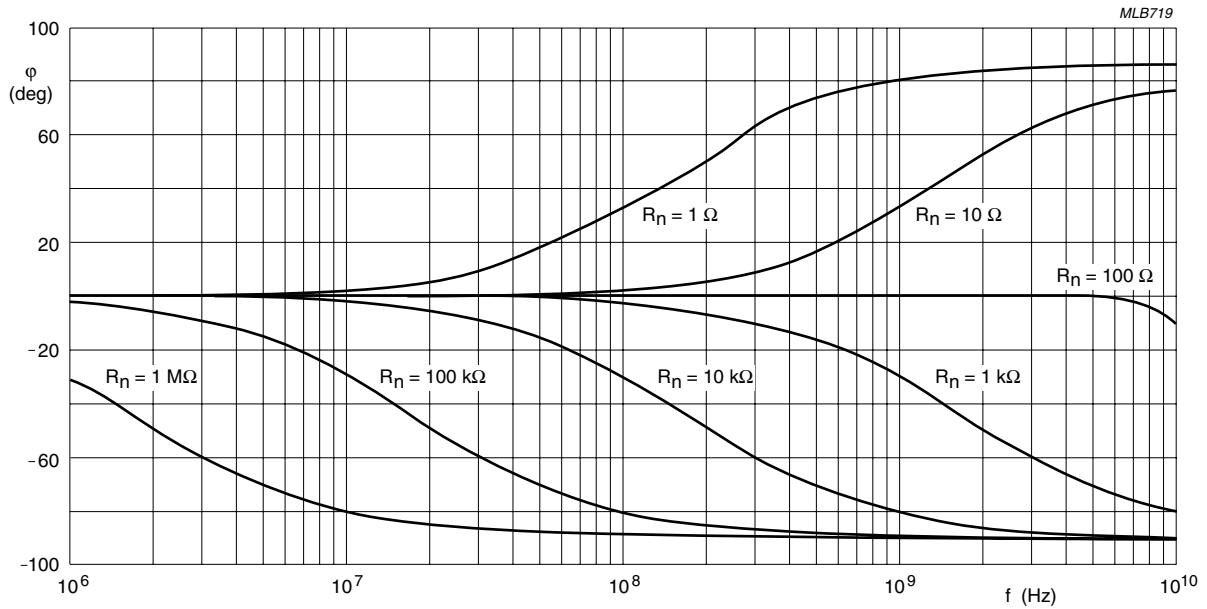
**Fig. 6** Phase shift as a function of frequency for a chip resistor

Size 0805



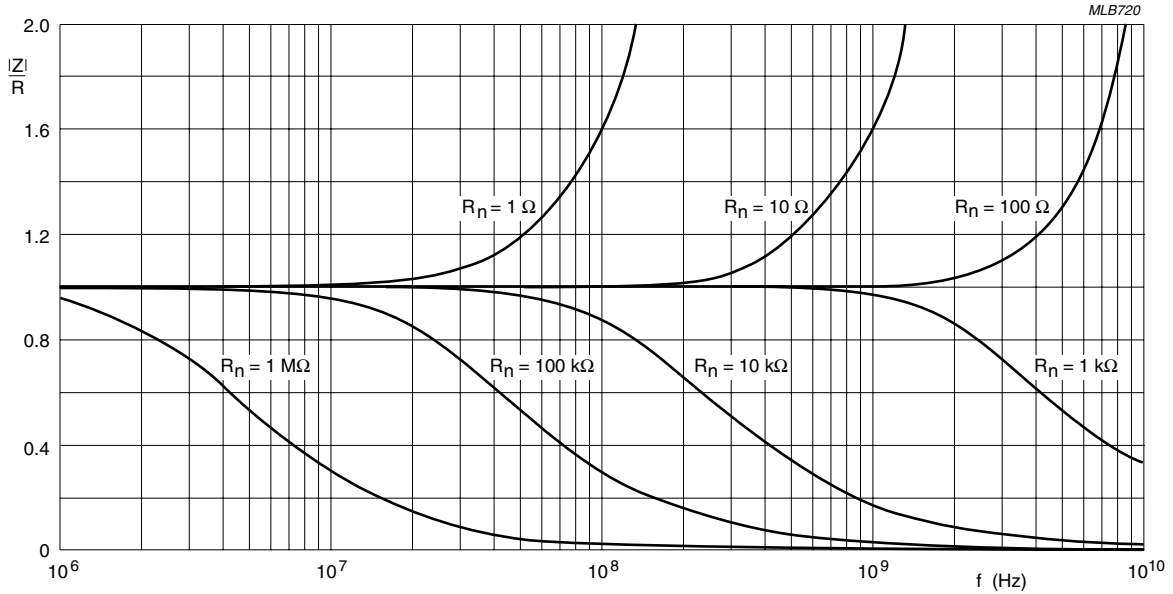
**Fig. 7** Impedance as a function of frequency for a chip resistor

Size 0805



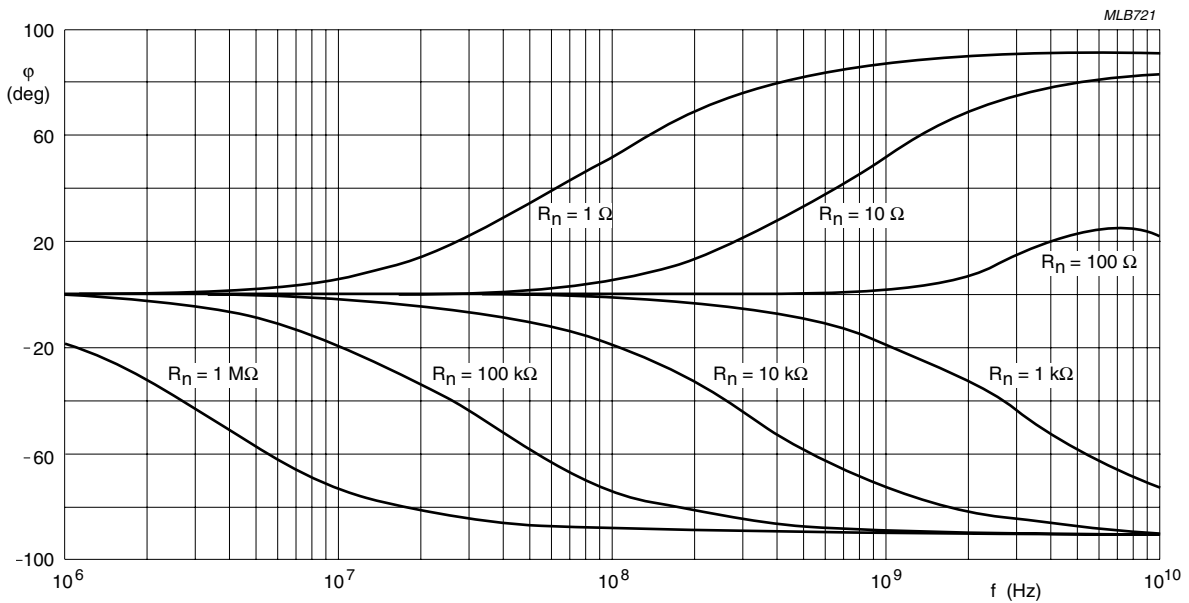
**Fig. 8** Phase shift as a function of frequency for a chip resistor

Size 1206



**Fig. 9** Impedance as a function of frequency for a chip resistor

Size 1206



**Fig. 10** Phase shift as a function of frequency for a chip resistor



**PULSE-LOAD BEHAVIOUR**

The load, due to a single pulse at which chip resistors fail by going open circuit, is determined by shape and time. A standard way to establish pulse load limits is shown in Table I.

With this test, it can be determined at which applied voltage the resistive value changes about 0.5% of its nominal value under the above mentioned

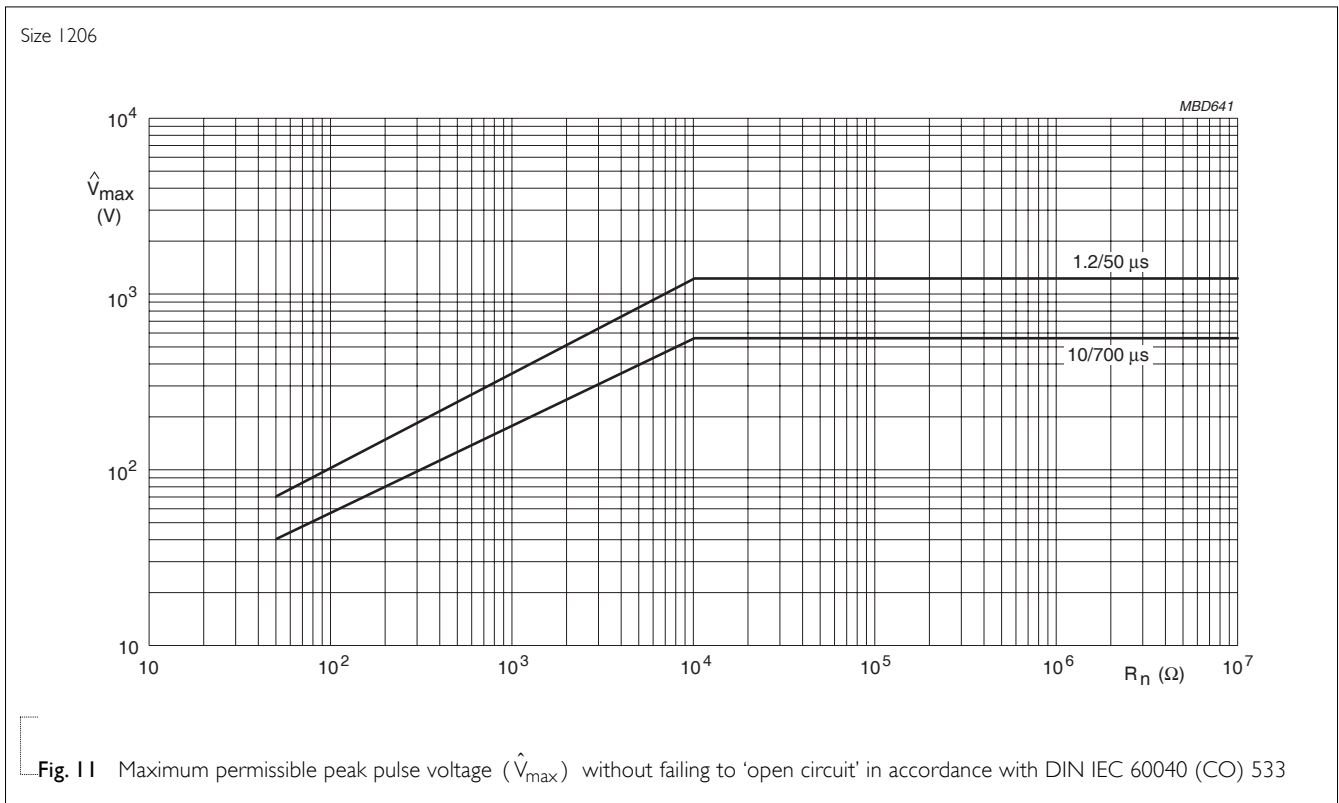
pulse conditions. Fig. II shows test results for the size 1206 chip resistors. If applied regularly the load is destructive, therefore the load must not be applied regularly during the load life of the resistors. However, the magnitude of a pulse at which failure occurs is of little practical value.

The maximum 'single-pulse' load

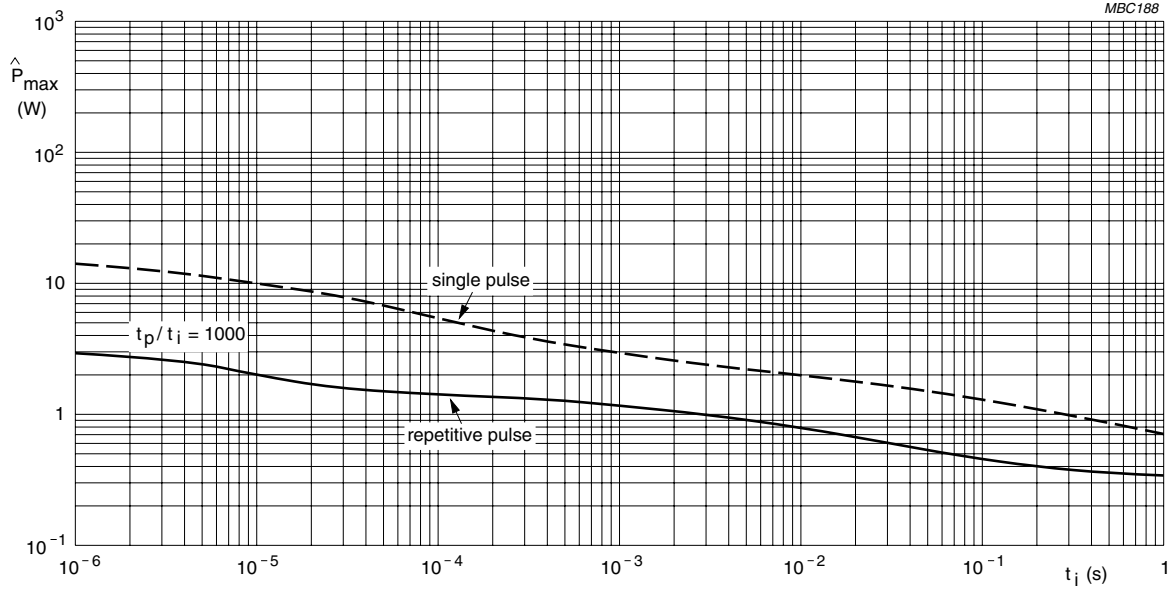
Table I Pulse load limits

| PARAMETER                 | VALUE             |
|---------------------------|-------------------|
| Exponential time constant | 50 to 700 $\mu$ s |
| Repetition time           | 12 to 25 s        |
| Amount of pulses          | 5 to 10           |

that may be applied in a regular way can be determined in a similar manner.

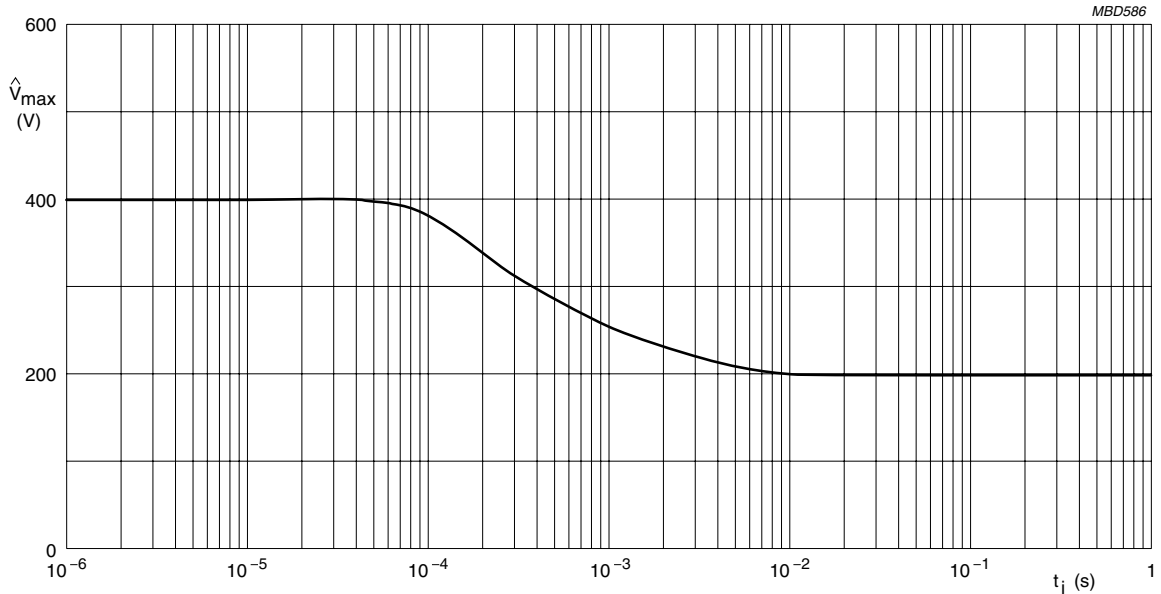


Size I206



**Fig. 12** Pulse on a regular basis; maximum permissible peak pulse power ( $\hat{P}_{max}$ ) as a function of pulse duration for  $R \leq 10 \text{ k}\Omega$ , single pulse and repetitive pulse  $t_p/t_i = 1,000$

Size I206



**Fig. 13** Pulse on a regular basis; maximum permissible peak pulse voltage ( $\hat{V}_{max}$ ) as a function of pulse duration ( $t_i$ ).

## DEFINITIONS OF PULSES

### SINGLE PULSE

The resistor is considered to be operating under single pulse conditions if, during its life, it is loaded with a limited number (approximately 1,500) of pulses over long time intervals (greater than one hour).

### REPETITIVE PULSE

The resistor is operating under repetitive pulse conditions if it is loaded by a continuous train of pulses of similar power.

The dashed line in Fig. 12 shows the observed maximum load for the Size 1206 chip resistors under single-pulse loading.

More usually, the resistor must withstand a continuous train of pulses of repetition time ' $t_p$ ' during which only a small resistance change is acceptable. This resistance change ( $\Delta R/R$ ) is equal to the change permissible under continuous load conditions. The continuous pulse train and small permissible resistance change reduces the maximum handling capability.

The continuous pulse train maximum handling capacity of chip resistors has been determined experimentally.

Measurements have shown that the handling capacity varies with the resistive value applied.

However, maximum peak pulse voltages as indicated in Fig. 13, should not be exceeded.

## DETERMINATION OF PULSE-LOAD

The graphs in Figs 12 and 13 may be used to determine the maximum pulse-load for a resistor.

- For repetitive rectangular pulses:

- $\frac{\hat{V}_i^2}{R}$  must be lower than the value of  $\hat{P}_{max}$  given by the solid lines of Fig. 12 for the applicable value of  $t_i$  and duty cycle  $t_p/t_i$ .
- $\hat{V}_i$  must be lower than the value of  $\hat{V}_{max}$  given in Fig. 13 for the applicable value of  $t_i$ .

- For repetitive exponential pulses:

- As for rectangular pulses, except that  $t_i = 0.5 \tau$ .

- For single rectangular pulses:

- $\frac{\hat{V}_i^2}{R}$  must be lower than the  $\hat{P}_{max}$  given by the dashed line of Fig. 12 for the applicable value of  $t_i$ .
- $\hat{V}_i$  must be lower than the value of  $\hat{V}_{max}$  given in Fig. 13 for the applicable value of  $t_i$ .

**DEFINITION OF SYMBOLS (SEE FIGURES 11, 12, 13, 14 AND 15)**

| Symbol          | Description  |
|-----------------|--|
| $\hat{P}$       | applied peak pulse power                                     |
| $\hat{P}_{max}$ | maximum permissible peak pulse power (Fig.12)                |
| $\hat{V}_i$     | applied peak pulse voltage (Fig. 14)                         |
| $\hat{V}_{max}$ | maximum permissible peak pulse voltage (Figs. 11, 13 and 15) |
| $R_{nom}$       | nominal resistance value                                     |
| $t_i$           | pulse duration (rectangular pulses)                          |
| $t_p$           | pulse repetition time  |
| $\tau$          | time constant (exponential pulses)                           |
| $T_{amb}$       | ambient temperature  |
| $T_m (max.)$    | maximum hot-spot temperature of the resistor                 |

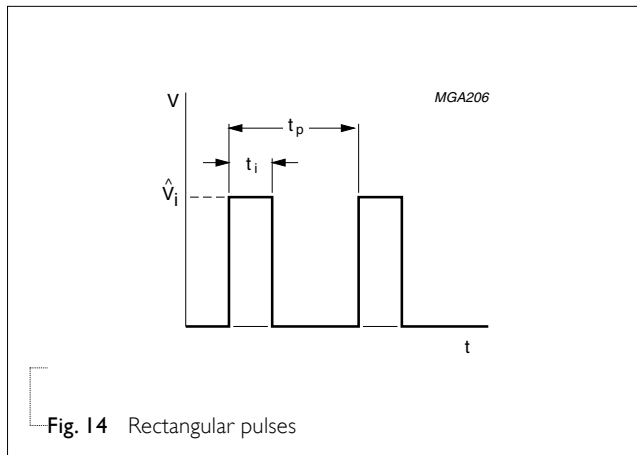


Fig. 14 Rectangular pulses

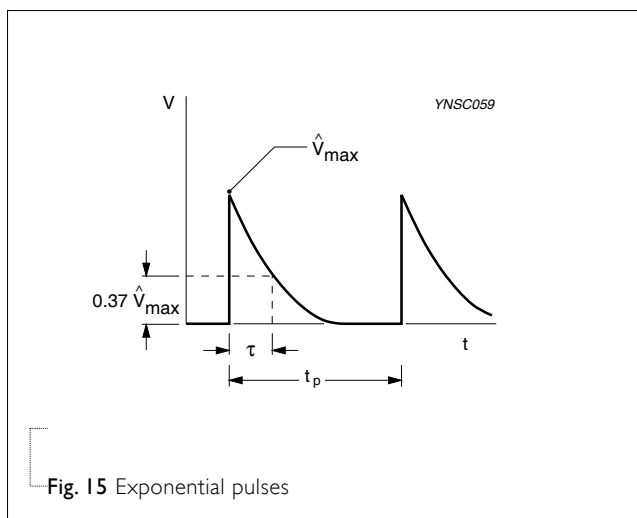


Fig. 15 Exponential pulses

**EXAMPLES**

Determine the stability of a typical resistor for operation under the following pulse-load conditions.

**CONTINUOUS PLUS TRAIN**

A 100 Ω resistor is required to operate under the following conditions:

$$V_i = 10 \text{ V}; t_i = 10^{-5} \text{ s}; t_p = 10^{-2} \text{ s}$$

Therefore:

$$\hat{P} = \frac{10^2}{100} = 1 \text{ W and } \frac{t_p}{t_i} = \frac{10^{-2}}{10^{-5}} = 1,000$$

For  $t_i = 10^{-5} \text{ s}$  and  $\frac{t_p}{t_i} = 1,000$ , Fig. 12 gives

$$\hat{P}_{max} = 2 \text{ W and Fig. 13 gives } \hat{V}_{max} = 400 \text{ V}$$

As the operating conditions  $\hat{P} = 1 \text{ W}$  and  $\hat{V}_i = 10 \text{ V}$  are lower than these limiting values, this resistor may be safely used.

**SINGLE PULSE**

A 10 kΩ resistor is required to operate under the following conditions:

$$\hat{V}_i = 250 \text{ V}; t_i = 10^{-5} \text{ s}$$

Therefore:

$$\hat{P}_{max} = \frac{250^2}{10,000} = 6.25 \text{ W}$$

The dashed curve of Fig. 12 shows that at  $t_i = 10^{-5} \text{ s}$ , the permissible  $\hat{P}_{max} = 10 \text{ W}$  and Fig. 13 shows a permissible  $\hat{V}_{max}$  of 400 V, so this resistor may be used.

**MECHANICAL DATA**

**MASS PER 100 UNITS**

Table 2 Single resistor chips type

| PRODUCT SIZE CODE | MASS (g) |
|-------------------|----------|
| 0201              | 0.016    |
| 0402              | 0.058    |
| 0603              | 0.192    |
| 0805              | 0.450    |
| 1206              | 0.862    |
| 1210              | 1.471    |
| 1218              | 2.703    |
| 2010              | 2.273    |
| 2512              | 3.704    |

Table 3 Resistor arrays, network and RF attenuators

| PRODUCT SIZE CODE | TYPE     | MASS (g) |
|-------------------|----------|----------|
| 0404              | ATV321   | 0.100    |
| 2 x 0201 (4P2R)   | YCI02    | 0.052    |
| 2 x 0402 (4P2R)   | YCI22    | 0.100    |
| 2 x 0402 (4P2R)   | TCI22    | 0.112    |
| 4 x 0402 (8P4R)   | YCI24    | 0.281    |
| 4 x 0402 (8P4R)   | TCI24    | 0.311    |
| 2 x 0603 (4P2R)   | YCI62    | 0.376    |
| 4 x 0603 (8P4R)   | YC/TCI64 | 1.031    |
| 1220 (8P4R)       | YC324    | 2.703    |
| 0616 (16P8R)      | YC248    | 0.885    |
| 0612 (10P8R)      | YCI58    | 0.855    |
| 1225 (10P8R)      | YC358    | 3.333    |

**FAILURE IN TIME (FIT)**

**CALCULATION METHOD:**

According to Yageo calculation, assuming components life time is following exponential distribution and using 60% confidence interval (60% C.I.) in Homogeneous Poisson Process; therefore the FIT is calculated by number of tested Failure in Endurance Test (rated power at 70°C for 1,000 hours, "IEC 60115-1 4.25.1") as following:

$$FIT (\lambda) = \frac{60\% \text{ C.I. number of estimated failure}}{\text{Accumulated test time}} \times 10^9$$

Table 4 FIT of single resistor chips

| TYPE   | FIT in 1999-2007 | ACCUMULATION TEST in 1999-2007 (hours) |
|--------|------------------|--|
| RC0201 | 146              | 6,280,000                              |
| RC0402 | 65               | 14,150,000                             |
| RC0603 | 63               | 14,650,000                             |
| RC0805 | 63               | 14,720,000                             |
| RC1206 | 69               | 13,380,000                             |
| RC1210 | 78               | 11,750,000                             |
| RC2010 | 65               | 14,190,000                             |
| RC2512 | 81               | 11,310,000                             |

Table 5 FIT of resistor arrays and network

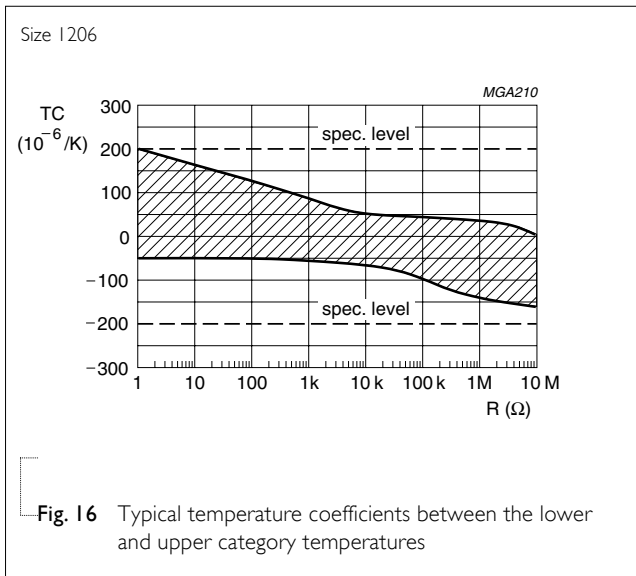
| TYPE  | FIT in 1999-2007 | ACCUMULATION TEST in 1999-2007 (hours) |
|-------|------------------|--|
| YCI22 | 590              | 1,560,000                              |
| TCI64 | 548              | 1,560,000                              |
| YCI24 | 390              | 1,560,000                              |
| YCI58 | 390              | 1,560,000                              |
| YCI64 | 339              | 1,710,000                              |
| YC248 | 390              | 1,560,000                              |
| YC324 | 390              | 1,560,000                              |
| YC358 | 390              | 1,560,000                              |

**TESTS AND PROCEDURES**

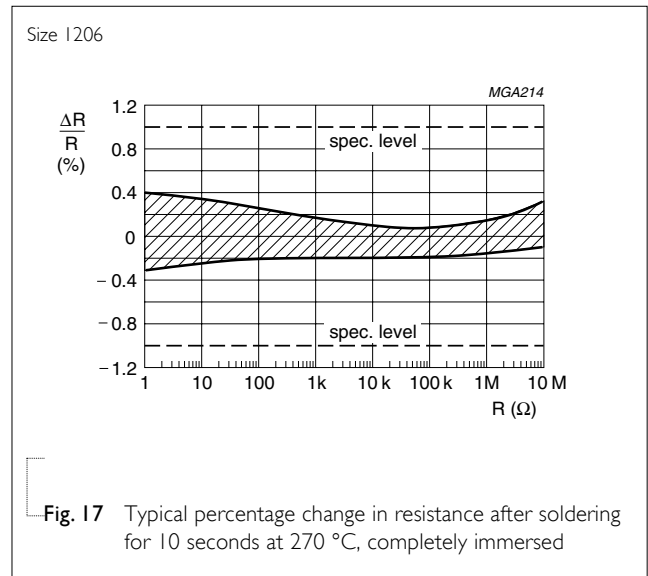
To guarantee zero defect production standard, Statistical Process Control is an essential part of our production processes. Furthermore, our production process is operating in accordance with "ISO 9000".

Essentially all tests on resistors are carried out in accordance with the schedule of "IEC publication 60115-1" in the specified climatic category and in accordance with "IEC publication 60068", "MIL-STD", "JIS C 5202", and "EIA/IS", etc. In some instances deviations from the IEC recommendations are made.

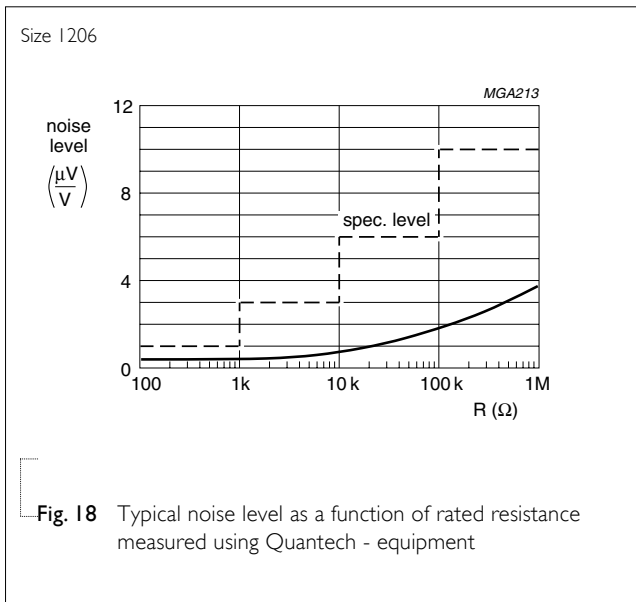
Tests and their requirements are described in detail in the data sheets.



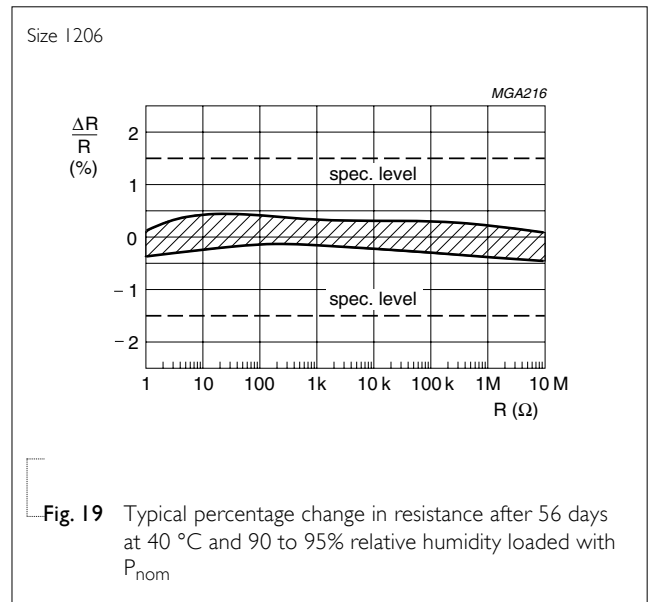
**Fig. 16** Typical temperature coefficients between the lower and upper category temperatures



**Fig. 17** Typical percentage change in resistance after soldering for 10 seconds at 270 °C, completely immersed

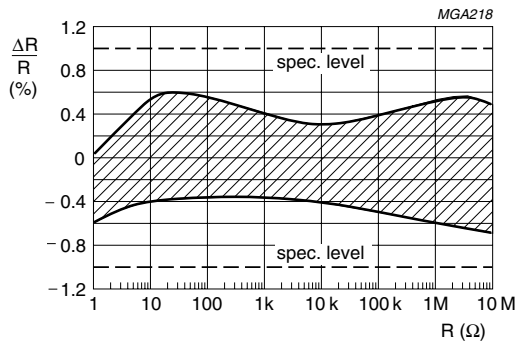


**Fig. 18** Typical noise level as a function of rated resistance measured using Quantech - equipment



**Fig. 19** Typical percentage change in resistance after 56 days at 40 °C and 90 to 95% relative humidity loaded with  $P_{nom}$

Size 1206



**Fig. 20** Typical percentage change in resistance after 1,000 hours loaded with  $P_{nom}$  at 70 °C ambient temperature

REVISION HISTORY

| REVISION  | DATE         | CHANGE NOTIFICATION | DESCRIPTION   |
|-----------|--------------|---------------------|---|
| Version 7 | Mar 25, 2008 | -                   | - Headline changes to Introduction Thick Film Chip Resistor<br>- Add international standard and failures in time  |
| Version 6 | Dec 15, 2004 | -                   | - Converted to Yageo / Phycomp brand<br>- Separated "Marking" into an individual data sheet<br>- Mechanical data extended from sizes 0201 to 2512, resistor arrays/network and attenuators as well<br>- Impedance chart for size 0402 added |
| Version 5 | Jul 23, 2004 | -                   | - Size extended to 0201   |
| Version 4 | Aug 19, 2004 | -                   | - Updated company logo  |
| Version 3 | May 30, 2001 | -                   | - Converted to Phycomp brand  |